

数字化可视室内机

快速操作手册

RoHS



一、室内机概况

1.1 平面示意图

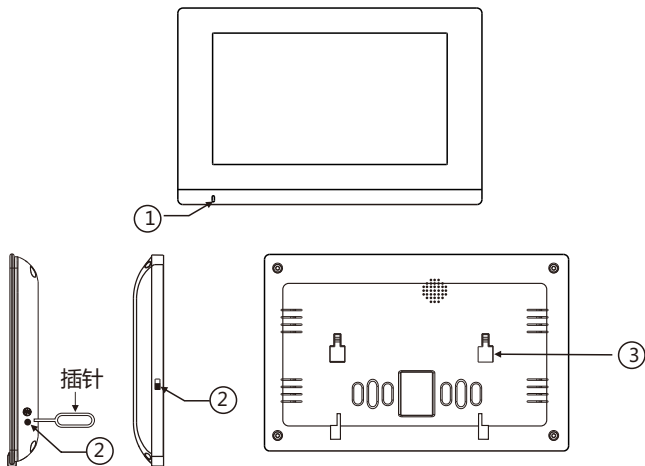

序号功能说明

① 麦克风

② 电源开关

③ 挂机扣位

因产品款式不同，部分产品电源开关，可能会用到插针来操作。

技术参数

工作电压	DC 13-17V(G2) DC 20-24V (G2.3W)	工作温度	-20-55℃
待机电流	230mA	待机功耗	3W
工作电流	320mA	通话方式	双向通话

1.2 安装步骤

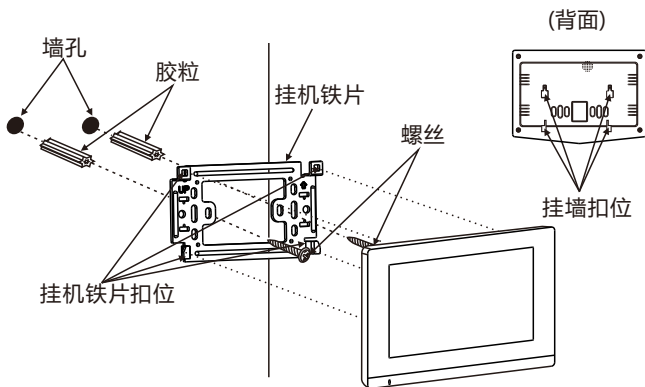

做安装标识→打胶粒→固定挂机铁片→对准扣位挂好

1.3 接线图

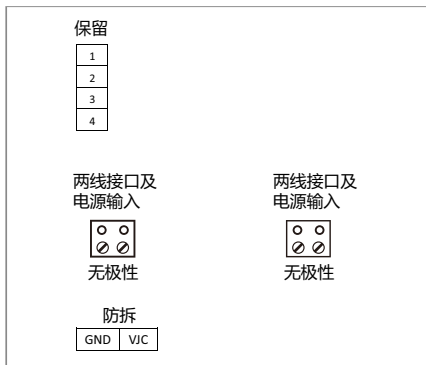



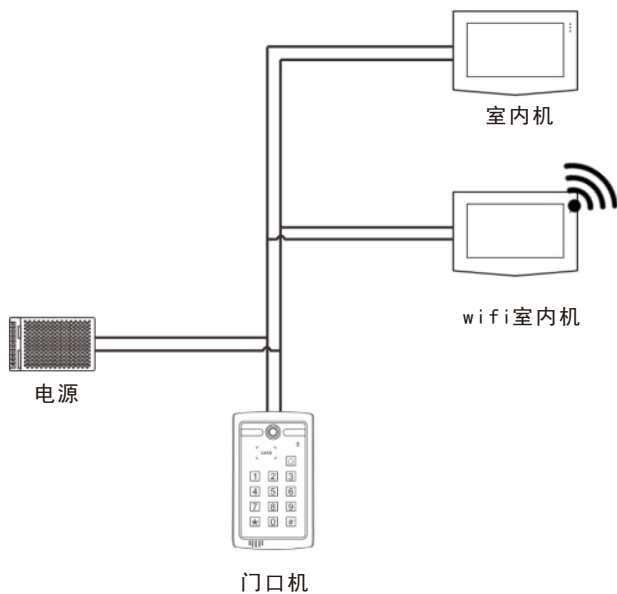

1.4 系统架构图

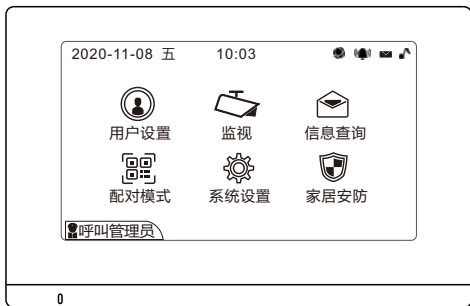

二、室内机操作说明

2.1主界面



状态提示	灰色图标
 网络	网络不通
 报警	无报警信息
 信息	无信息
 铃声	免打扰模式

2.2 用户设置

1



2

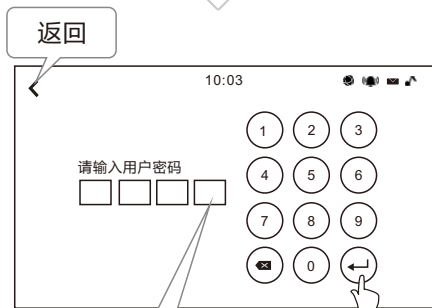

输入4位数密码
出厂原始密码：1234

A callout box with a pointer to the input boxes, containing the text '输入4位数密码' and '出厂原始密码：1234'.

3



返回

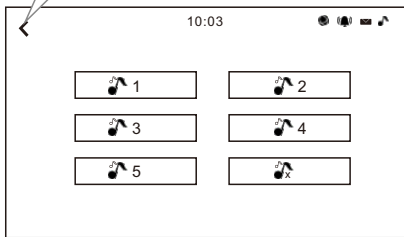

选择自己喜欢的铃声

4

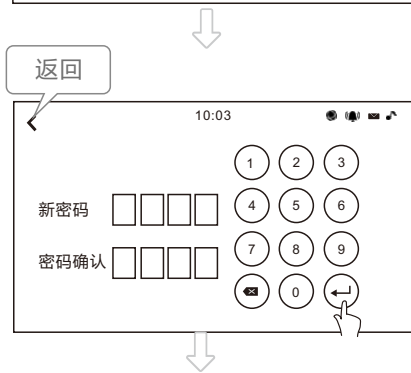
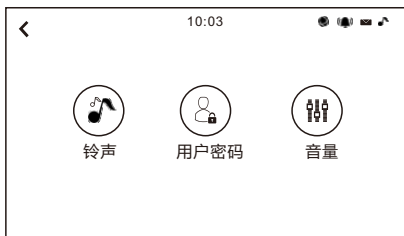

输入4位数新密码，可以重新设定新密码

5



选择自己喜欢的铃声及音量大小

2.3 监视

1



2

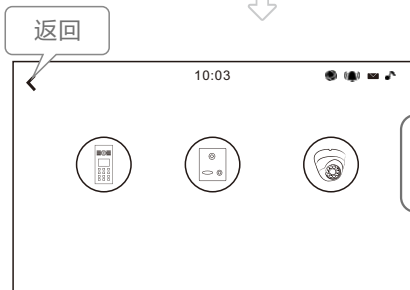

监视大楼门口机01/02/03

监视别墅门口机01/02

监视摄像机

3



• 打开大门

4

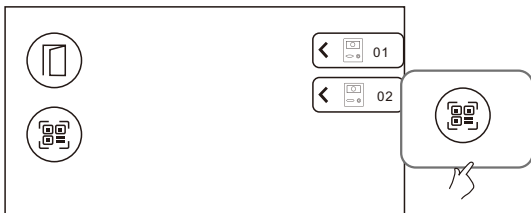

显示门口机的二维码

5

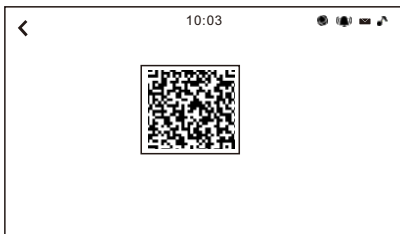

手机安装CCL-SH APP，在主界面中点击左上角“”，扫描门口机的二维码绑定设备(可以在室内机上扫二维码，也可以在门口机背面扫二维码)。



CCL-SH APP主界面

门口机背面二维码

2.4 信息查询

1



返回

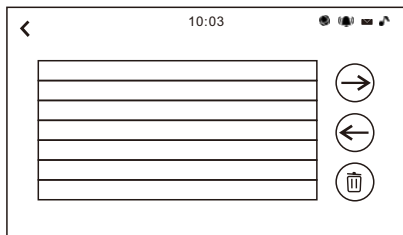
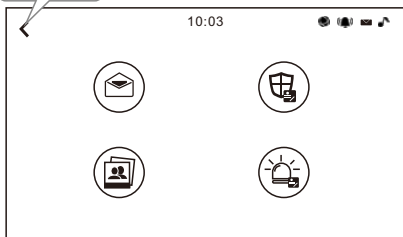

2.5 系统设置

1



该设置仅限工程操作。
初始密码：6666





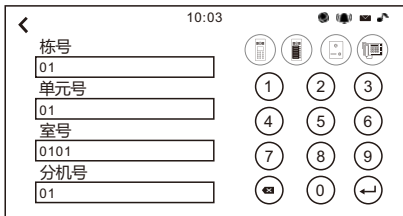
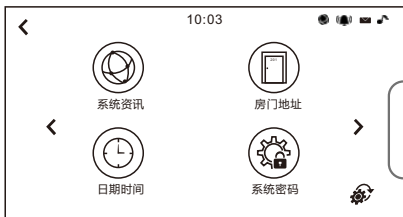
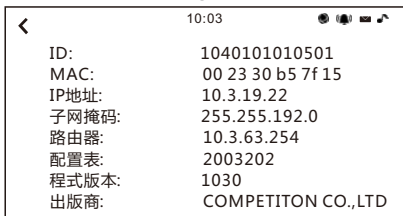
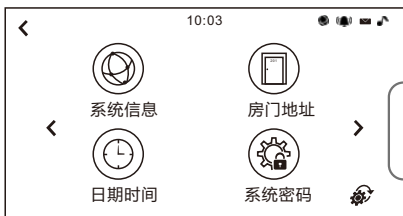

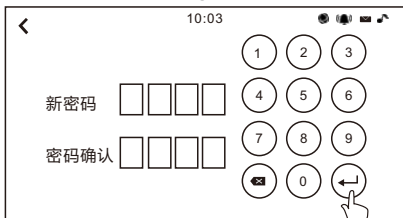
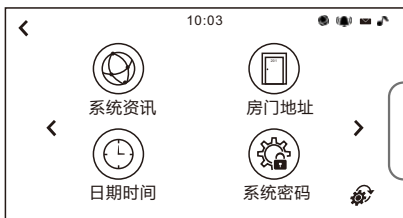
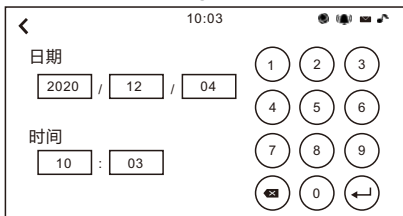
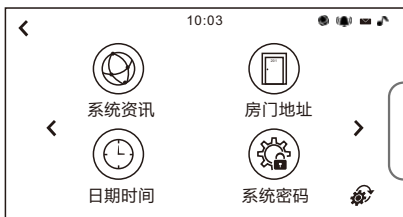

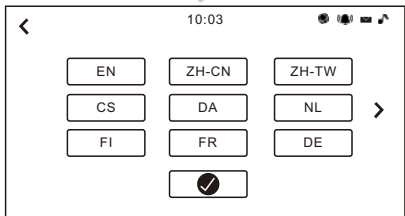
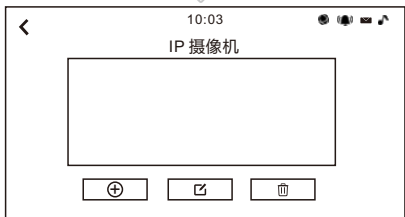

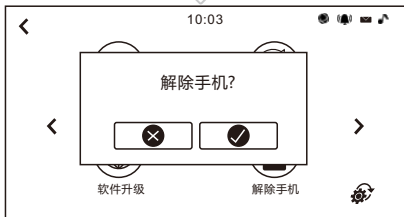
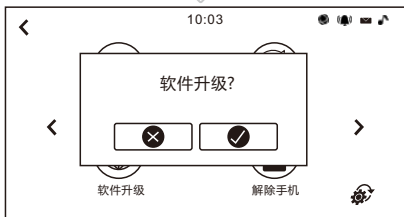

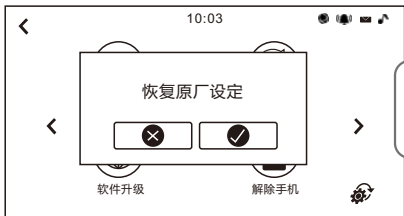
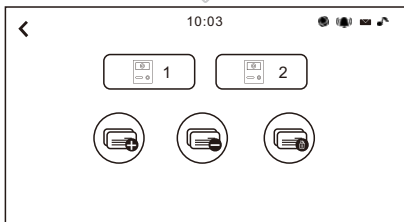

2.6 家居安防

1



- 先选择延时时间后，再选择情景模式的设定。



报警延时可选时间。系统默认为：60秒。

防区说明

室内机支持8防区：

1-5 按布防设备不同设为：门磁、窗磁，或红外。

6-8：24小时布防，默认：烟感、瓦斯、紧急求救。

布防模式说明		
模式	防区	说明
在家模式	1-5	撤防
外出模式	1-5	布防
就寝模式	1-2布防，3-5撤防。	
自定义模式	自定义1-5防区状态。	
SOS	可立即报警。	

2.7 呼叫管理员

1

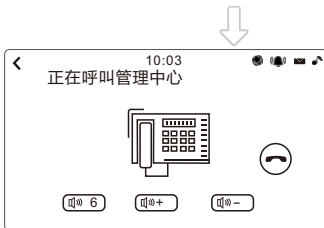

挂机

三、带WIFI功能室内机--WIFI的设定

※设备通电后，确保WIFI路由器信号工作正常情况下操作；

步骤1：首先打开APP CCL-SH，申请注册帐号登陆后，切换至手机WIFI设置并连接室内机SSID，SSID名称为

“happy2_*****_690”；

步骤2：连接成功后切换至CCL-SH 主界面点击“搜索新设备”，弹出提示“已和设备连线”点确认下一步；

步骤3：选择弹出可用网络中的WIFI信号，输入对应WIFI密码，等待设备完成配置；如下图序操作：



图1



图2



图3



图4

※更改（重置）WIFI设置：

方式：关闭原配置wifi信号路由器的电源或者远离原配置wifi路由器信号覆盖范围，室内机重新上电后等待1-2分钟出现SSID“happy2_*****_690”，按WIFI配置说明重新操作即可。

四、手机APP操作

① APP下载

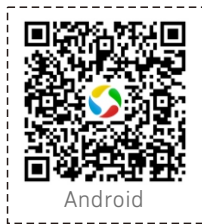

1.扫描二维码下载。

或 安卓：在应用商城搜索“CCL-SH APP”；

iOS：在App Store搜索“CCL-SH APP”下载。

2.Android在6.0及以上版本运行。

3.iOS在9.0及以上版本运行。

② 申请注册新账号

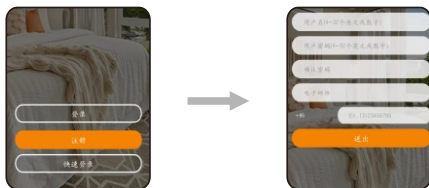

• 打开CCL-SH APP，注册新新账号,填写基本资料,完成注册。

③ 登录

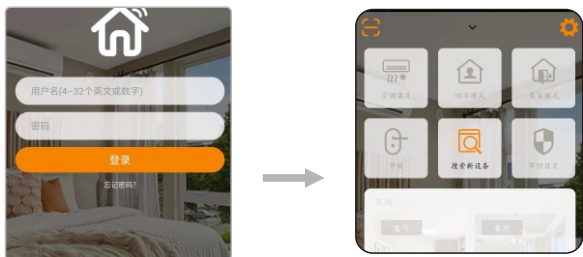

- 注册完，登录APP，输入帐户，密码后，进入主界面。

④ 绑定门口机



CCL-SH APP主界面

门口机背面二维码

在主界面中点击左上角“”，扫描门口机背面的二维码绑定门口机。

④ 绑定室内机

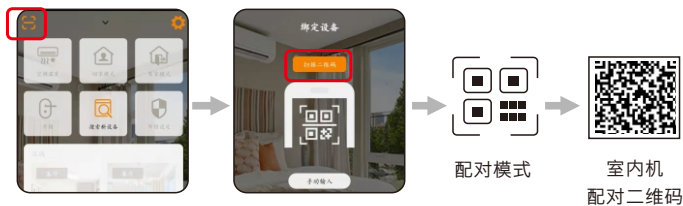

CCL-SH APP主界面

配对模式

室内机
配对二维码

在APP主界面中点击左上角“”，再点击室内机主界面“配对模式”，显示二维码，扫描室内机配对二维码，绑定室内机。